



Beta H-SAFE

*Beta szerszám
megtartó rendszer
Height-Safe*



Beta
Height-Safe

H-SAFE *Beta szerszám megtartó rendszer*

Magasban, vagy mozgó mechanikus részek mellett végzett munkáknál a biztonság a kockázatok, a költségek és a ráfordított idő csökkentésének fontos eleme:

IDŐ MEGTAKARÍTÁS:

egy leeső szerszám megrongálódhat, vagy megrongálhat egyéb tárgyakat, ami az adott munka elvégzéséhez szükséges idő meghosszabbodásával jár.

A KÖLTSÉGEK CSÖKKENTÉSE:

egy szerszám leeseése változó mértékben befolyásolhatja a járulékos költségeket, amelyek az elvesztett szerszám újra megvásárlásától a kártérítésig terjedhetnek.

A BIZTONSÁG NÖVELÉSE:

a legfontosabb cél az emberi egészség védelme a biztonságos munkavégzés segítségével.



SZÉLENERGIA



PETROLKÉMIAI IPAR



HAJÓIPAR



NUKLEÁRIS IPAR



ÉPÍTŐIPAR



A H-SAFE megtartó rendszert a Beta üzemekben tervezték, tesztelték és gyártották



A Beta H-SAFE biztonsági rendszer segítségével a szerszámok kényelmes és biztonságos módon mindig kéznél vannak

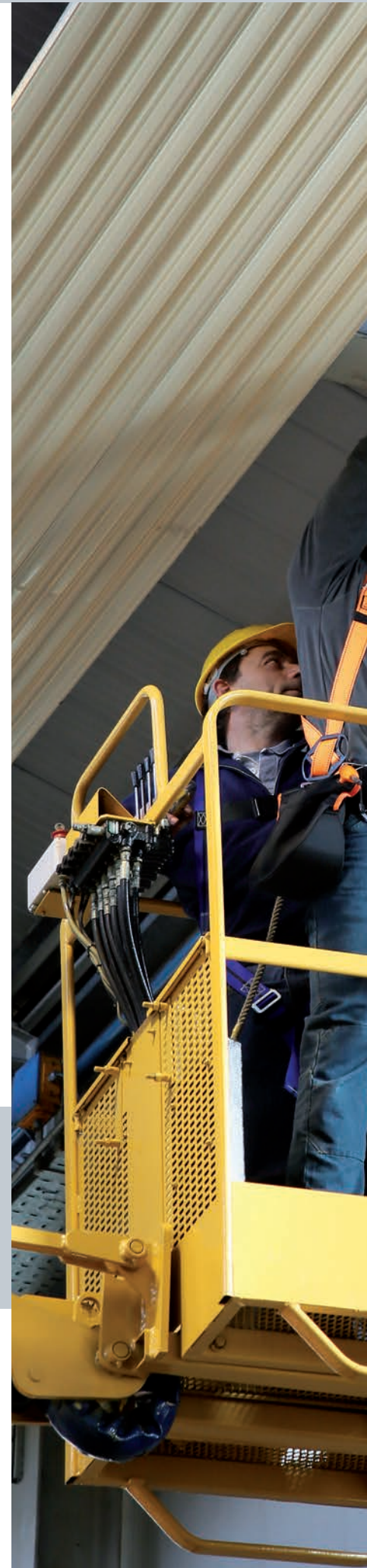



A Beta H-SAFE szerszám választék több mint 200 hivatkozást tartalmaz, ezért sikerült egy olyan sajátos megtartó rendszert tervezni, ami képes ellenállni a legszigorúbb mechanikus igénybevételeknek, ami a maximális biztonság garanciája.

Fontos a felhasználási kényelem is, ezért a kettős aktív részből álló szerszámok, mint a 42. cikkszámú csillag-villáskulcs, egy olyan huzal segítségével csatlakoznak, amely végigfuthat a szerszámtesten, míg a csavaró mozgással használt szerszámok, mint például a csavarhúzó esetében egy szabadon elforduló gyűrűvel csatlakoznak, ami megakadályozza a rögzítőhuzal felcsavarását.



A fogóknál egy furat helyezkedik el a markolaton, amiben a fogó acéljából készített mag található. A furat a markolat hátsó részére került, hogy ne akadályozza a mozgásokat, ami magasfokú kényelmet biztosít.

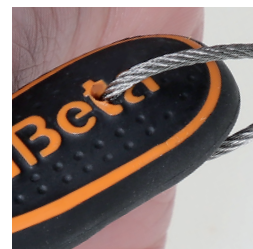

H-SAFE SZERSZÁMOK

Csillag-villáskulcs,
krómozott

UNI-ISO 7738 DIN 3113

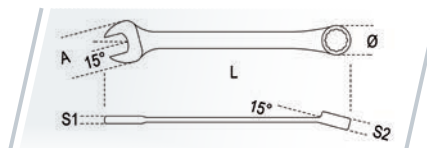

42HS

🔧	mm	L mm	A mm	Ø mm	S1 mm	S2 mm	g
000424006	6x6	95	15,2	10,1	3,4	5,2	12
000424007	7x7	105	17,1	10,8	3,6	5,7	16
000424008	8x8	116	19,0	12,3	3,9	6,2	23
000424009	9x9	127	20,9	13,7	4,2	6,7	27
000424010	10x10	137	22,8	15,1	4,5	7,1	35
000424011	11x11	148	24,8	16,5	4,8	7,5	44
000424012	12x12	158	26,9	18,2	5,1	7,9	54
000424013	13x13	169	28,8	19,6	5,4	8,4	66
000424014	14x14	180	30,8	21,0	5,7	8,8	80
000424015	15x15	190	32,7	22,4	6,0	9,2	90
000424016	16x16	201	34,6	23,8	6,3	9,7	105
000424017	17x17	212	36,6	25,2	6,7	10,2	120
000424018	18x18	222	38,5	26,7	7,0	10,8	140
000424019	19x19	233	40,5	28,0	7,3	11,4	160
000424020	20x20	243	42,5	29,4	7,6	11,9	180
000424021	21x21	254	44,5	30,7	7,9	12,4	205
000424022	22x22	264	46,4	32,2	8,1	12,8	225
000424023	23x23	275	48,4	33,5	8,3	13,2	255
000424024	24x24	285	50,3	34,9	8,5	13,5	290
000424025	25x25	296	52,3	36,2	8,7	13,8	310
000424026	26x26	307	54,3	37,6	8,9	14,2	345
000424027	27x27	317	56,2	39,0	9,1	14,6	375
000424028	28x28	328	58,2	40,3	9,3	15,0	400
000424029	29x29	338	60,2	41,9	9,5	15,3	450
000424030	30x30	349	62,1	43,0	9,7	15,6	500
000424032	32x32	370	66,0	45,7	10,1	16,2	565
000424034	34x34	391	70,0	48,5	10,5	16,8	680
000424036	36x36	412	73,9	51,3	10,9	17,5	825

42HS/AS

🔧	mm	L mm	A mm	Ø mm	S1 mm	S2 mm	g
000424106	1/4x1/4	95	15,2	10,1	3,4	5,2	12
000424108	5/16x5/16	116	19,0	12,3	3,9	6,2	23
000424110	3/8x3/8	137	22,8	15,1	4,5	7,1	35
000424111	7/16x7/16	148	24,8	16,5	4,8	7,5	44
000424113	1/2x1/2	169	28,8	19,6	5,4	8,4	66
000424114	9/16x9/16	180	30,8	21,0	5,7	8,8	80
000424116	5/8x5/8	201	34,6	23,8	6,3	9,7	105
000424117	11/16x11/16	212	36,6	25,2	6,7	10,2	120
000424119	3/4x3/4	233	40,5	28,0	7,3	11,4	160
000424121	13/16x13/16	254	44,5	30,7	7,9	12,4	205
000424122	7/8x7/8	264	46,4	32,2	8,1	12,8	225
000424124	15/16x15/16	285	50,3	34,9	8,5	13,5	290
000424125	1x1	296	52,3	36,2	8,7	13,8	310
000424127	1.1/16x1.1/16	317	56,2	39,0	9,1	14,6	375
000424129	1.1/8x1.1/8	338	60,2	41,9	9,5	15,3	450
000424132	1.1/4x1.1/4	370	66,0	45,7	10,1	16,2	565
000424133	1.5/16x1.5/16	391	70,0	48,5	10,5	16,8	680

55HS

Villáskulcs, krómozott

UNI-ISO 10102 DIN 3110

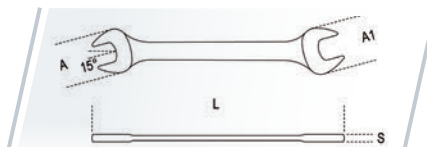

🔧	mm	L mm	A mm	A1 mm	S mm	g	🔧	mm	L mm	A mm	A1 mm	S mm	g
000554012	6x7	120	15,5	17,5	3,5	21	000554075	20x22	236	43,5	47,5	7,0	207
000554021	8x9	140	19,5	21,5	4,0	34	000554078	21x23	245	45,5	49,5	7,6	245
000554030	10x11	155	23,5	25,5	4,5	47	000554081	22x24	245	45,5	49,5	7,6	233
000554042	12x13	170	27,5	29,5	5,0	69	000554090	24x27	262	51,5	55,5	8,0	310
000554054	14x15	185	31,5	33,5	5,5	92	000554108	30x32	297	63,5	67,5	9,0	490
000554060	16x17	202	35,5	37,5	6,0	122	000554117	34x36	325	68,4	76,1	11,0	614
000554066	18x19	220	39,5	41,5	6,5	134							

142HS

Csillag-villáskulcs
irányváltós racsnival

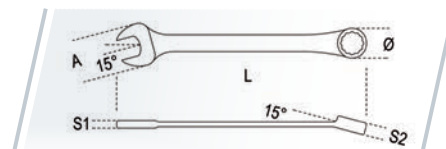

📄	📏 mm	L mm	A mm	Ø mm	S1 mm	S2 mm	📊 g	📄	📏 mm	L mm	A mm	Ø mm	S1 mm	S2 mm	📊 g
001424008	8x8	136	18,0	18,2	5,1	7,4	43	001424017	17x17	233	38,4	34,5	8,8	10,7	191
001424009	9x9	143	20,0	19,7	5,4	7,4	44	001424018	18x18	239	39,9	34,5	9,0	11,0	210
001424010	10x10	159	22,0	21,5	5,8	7,6	60	001424019	19x19	248	41,5	35,6	9,5	11,2	241
001424011	11x11	168	24,5	23,1	6,1	8,2	67	001424021	21x21	285	45,2	41,4	10,5	13,0	280
001424012	12x12	174	26,5	24,3	6,4	8,9	93	001424022	22x22	285	45,8	42,0	10,2	13,0	344
001424013	13x13	180	27,6	26,5	6,7	9,0	98	001424024	24x24	325	51,5	47,5	11,0	14,5	474
001424014	14x14	190	31,4	28,3	7,4	9,4	115	001424027	27x27	355	59,5	52,0	14,0	14,5	670
001424015	15x15	200	33,4	29,7	7,7	9,4	143	001424030	30x30	420	64,0	59,0	17,0	14,5	1000
001424016	16x16	216	34,6	32,6	8,1	9,9	168	001424032	32x32	420	64,0	59,0	17,0	14,5	1000

932HS

Tizenkétszögű pipakulcs,
fényes krómozott

NF E 74.303

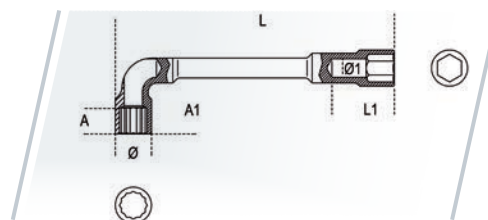
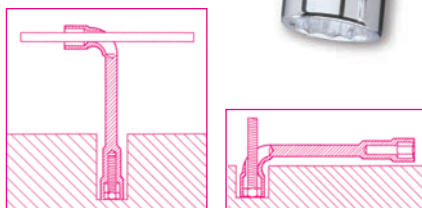

📄	📏 mm	Ø mm	L mm	Ø1 mm	A mm	A1 mm	L1 mm	📊 g	📄	📏 mm	Ø mm	L mm	Ø1 mm	A mm	A1 mm	L1 mm	📊 g
009324006	6x6	11,5	110	5,0	8,0	15,0	15,0	55	009324013	13x13	19,5	154	9,5	16,0	28,0	34,0	175
009324007	7x7	12,5	116	6,0	9,0	18,0	15,0	60	009324014	14x14	21,5	167	10,0	17,0	28,0	34,0	220
009324008	8x8	13,0	120	6,0	11,0	20,0	21,0	65	009324015	15x15	22,5	182	10,0	17,0	29,0	40,0	235
009324009	9x9	14,0	125	7,0	11,0	20,0	21,0	75	009324016	16x16	24,5	193	11,0	20,0	33,0	40,0	335
009324010	10x10	16,5	133	8,0	13,0	22,0	25,0	105	009324017	17x17	26,0	198	12,0	20,0	34,0	44,0	340
009324011	11x11	17,5	143	8,5	14,0	23,0	25,0	125	009324018	18x18	26,5	215	13,0	20,0	34,0	44,0	370
009324012	12x12	19,0	148	8,5	14,0	25,0	25,0	165	009324019	19x19	29,0	220	14,0	22,0	35,0	48,0	435

111HS

Állítható villáskulcs skálával, krómozott

- Állítható jobbmenetes pófák
- 22,5°-os fej mérőskálával milliméterben és collban

DIN 3117 ISO 6787

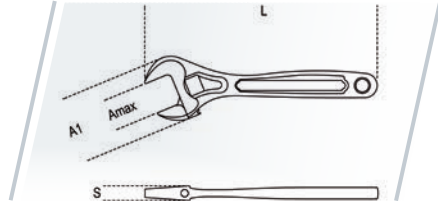

Art.	L mm	L"	A max mm	A1 mm	S mm	g
001114020	200	8	28	62,0	14,0	325
001114025	250	10	34	70,0	16,0	505
001114030	300	12	35	84,0	18,0	790
001114038	380	15	45	97,0	20,0	1320
001114045	450	18	54	115,0	22,5	2043

91HS

Feltűző csillagkulcs csőtoldatok, krómozott

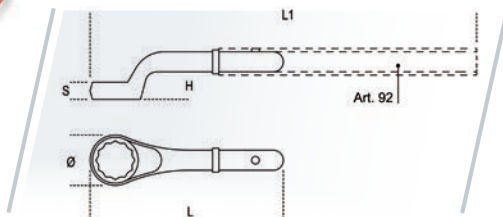

Art.	mm	Ø mm	H mm	L mm	L1 mm	S mm	g
000914236	36	54	35,5	245	735	20,0	80
000914241	41	62	39,5	265	750	22,0	95
000914246	46	69	40,0	280	910	23,0	120

a kiegészítők (tájoló, kulcsok és lemezek) cseréje csak a földön végezhető el! ⚠

93HS

Állványozó csillagkulcs állványcsavarokhoz, krómozott

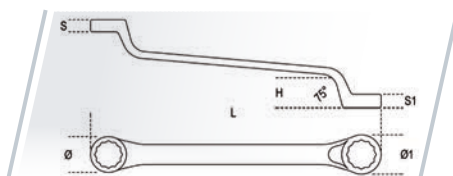

Art.	mm	L mm	Ø mm	Ø1 mm	H mm	S mm	S1 mm	g
000934021	21x22	310	35,0	36,0	32,0	16,0	16,5	580

360HS

„Stillson” csőfogó
kovácsolt acélból

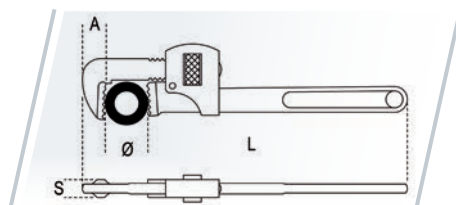

art.	L mm	Ø max "	Ø max mm	A mm	S mm	g
003604025	250	1" gas	34	22	16	520
003604035	350	1 1/2" gas	49	27	21	1003
003604045	450	2" gas	60	30	23	1725
003604060	600	2 1/2" gas	76	38	27	2743

666HS

Kioldó nyomatékkulcs irányváltós
racsnival jobb oldali meghúzáshoz
meghúzási pontosság ± 3%

UNI EN 26789 ISO 6789



LC system,
kétgolyós megtartó rendszer,
a tájoló csak gombnyomásra
enged ki

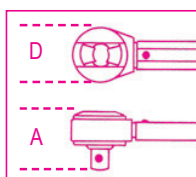

art.	Nm	Kgfm	lbf.ft	■	D mm	A mm	L mm	LC system	g
006664005	666HS/5	10÷50	1÷5	7÷37	3/8	30	33	312	660
006664010	666HS/10	20÷100	2÷10	15÷75	3/8	30	33	381	730
006664021	666HS/20LC	40÷200	4÷20	30÷150	1/2	40	43	470	1010
006664031	666HS/30LC	60÷300	6÷30	50÷220	1/2	40	43	598	1380

a kiegészítők (tájolók, kulcsok és lemezek) cseréje csak a földön végezhető el !

Irányváltós racsn

UNI-ISO 3315 DIN 3122

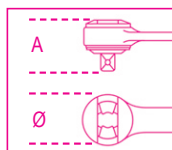

900E-HS/55



art.	L mm	Ø mm	A mm	■	g
009004880	125	25	18	1/4	90

910E-HS/55



art.	L mm	Ø mm	A mm	■	g
009104880	200	30	33	3/8	238

920E-HS/55LC



art.	L mm	Ø mm	A mm	■	LC system	g
009204860	275	40	43	1/2	✓	475

a kiegészítők (tájolók, kulcsok és lemezek) cseréje csak a földön végezhető el !

H-SAFE SZERSZÁMOK

T-szárú imbuszkulcs,
műanyag markolattal

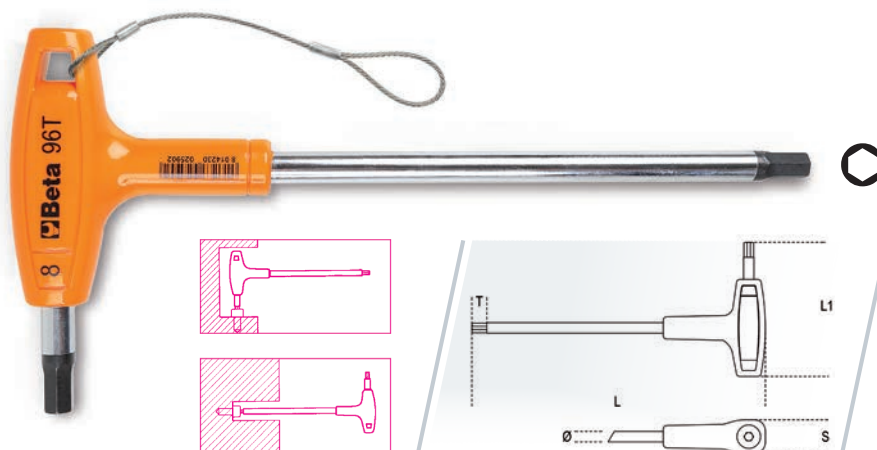

96THS

📏	mm	L mm	L1 mm	Ø mm	T mm	S mm	📊 g
000964935	2,5	153	55	4	8,0	13,4	21
000964936	3	153	55	4	8,5	13,4	21
000964938	4	179	70	5	10,0	17,8	40
000964940	5	200	84	6	11,0	22	70
000964941	6	221	103	7	12,0	24	97
000964943	8	255	117	10	14,0	26	215
000964945	10	285	132	12	16,0	29	338

96THS-AS

📏	"	L mm	L1 mm	Ø mm	T mm	S mm	📊 g
000964673	5/32	200	84	6	10,5	22	70
000964674	3/16	200	84	6	11,0	22	71
000964675	7/32	221	103	7	12,0	24	103
000964676	1/4	236	106	8	13,0	26	141
000964678	5/16	255	117	10	14,0	26	210
000964680	3/8	285	132	12	16,0	29	336

97TTX-HS

T-szárú Torx®-imbuszkulcs,
műanyag markolattal,
krómozott, fekete hegyek

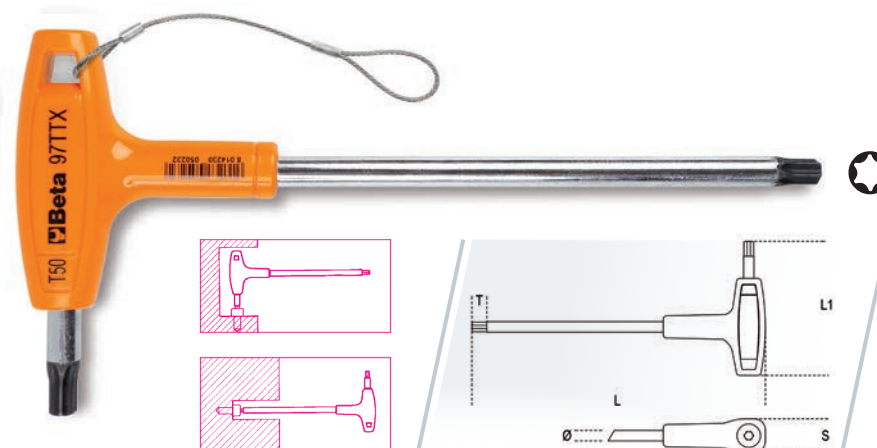

📏	⊙	L mm	L1 mm	S mm	📊 g	📏	⊙	L mm	L1 mm	S mm	📊 g
000974710	T10	179	70	13	18	000974730	T30	200	84	22	64
000974715	T15	179	70	13	21	000974740	T40	221	103	24	104
000974720	T20	179	70	18	36	000974745	T45	236	106	26	170
000974725	T25	179	70	18	42	000974750	T50	255	117	26	215

1290HS

Csavarhúzó hasítottfejű csavarokhoz

ISO 2380

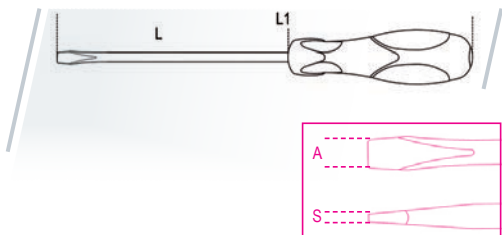

Modell	SxAxL mm	L1 mm	g	Modell	SxAxL mm	L1 mm	g
012904006	0,4x2,5x75	171	33,6	012904042	1x5,5x150	259	70,4
012904012	0,5x3x100	196	36,8	012904051	1,2x6,5x150	270	97,8
012904021	0,6x3,5x100	196	39,4	012904057	1,2x8x150	282	132,0
012904030	0,8x4x100	196	42,4	012904066	1,6x10x200	332	168,3
012904036	0,8x4x150	246	47,1				

1292HS

Csavarhúzó Phillips®-csavarokhoz

UNI/ISO 8764

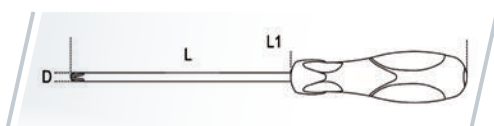

Modell	PHxDxL mm	L1 mm	g	Modell	PHxDxL mm	L1 mm	g
012924006	0x3x100	196	36,6	012924021	2x6x150	270	98,3
012924012	1x4,5x120	229	61,7	012924024	3x8x150	282	148,3

1294HS

Csavarhúzó hernyócsavarokhoz

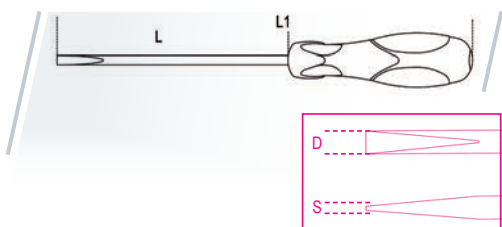

Modell	SxDxL mm	L1 mm	g	Modell	PHxDxL mm	L1 mm	g
012944003	0,5x2,5x60	156	33,0	012944012	0,8x4x100	196	42,2
012944006	0,6x3x75	171	35,4	012944018	1x5x125	234	66,6

1299HS

Csavarhúzó Pozidriv®- és Supadriv®-csavarokhoz

UNI/ISO 8764

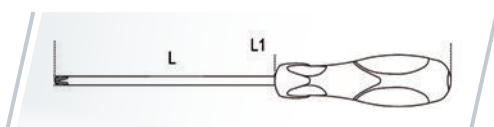

Modell	PZ	L mm	L1 mm	g	Modell	PZ	L mm	L1 mm	g
012994000	0	60	156	35,0	012994006	2	100	220	88,4
012994003	1	80	189	57,2	012994009	3	150	282	149,0

1032HS

Egyenes belső Seeger-fogó, barnított, PVC-bevonattal

UNI 7914 DIN 5256

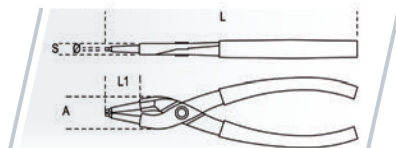

	L mm	∅ mm	∅1 mm	A mm	S mm	L1 mm	g
010324014	140x1,3	12÷25	1,3	20	9,0	20	100
010324017	180	19÷60	1,9	21	10,0	24	150

1034HS

90°-os hajlított belső Seeger-fogó, barnított, PVC-bevonattal

UNI 7914 DIN 5256

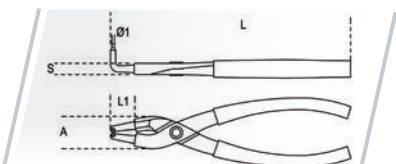

	L mm	∅ mm	∅1 mm	A mm	S mm	L1 mm	g
010344017	170	19÷60	1,9	21	10,0	15	150

1036HS

Egyenes külső Seeger-fogó, barnított, PVC-bevonattal

UNI 7915 DIN 5254

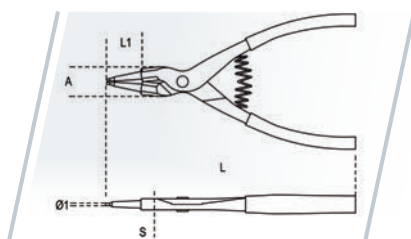

	L mm	∅ mm	∅1 mm	A mm	S mm	L1 mm	g
010364014	140x1,3	10÷25	1,3	20	9,0	20	100
010364017	175	19÷60	1,9	21	10,0	25	160

1038HS

90°-os hajlított külső Seeger-fogó, barnított, PVC-bevonattal

UNI 7915 DIN 5254

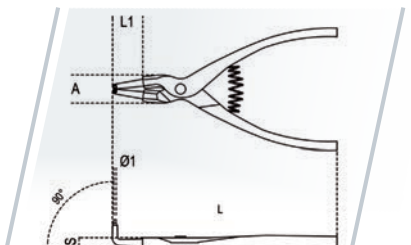

	L mm	∅ mm	∅1 mm	A mm	S mm	L1 mm	g
010384017	175	19÷60	-	21	10,0	23	160

1048BM-HS

Vízpumpafogó,
villás, bimateriál nyél

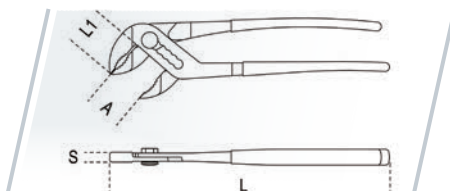

	L mm	A max mm	L1 mm	S mm	g
010484215	250	48	39	6,8	460

1052HS

Állítható önzáró fogó,
homorú pofájú, krómozott

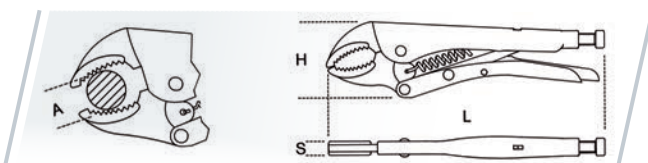

	L mm	A mm	A1 max mm	S mm	g
010524024	240	72	42	6,8	460

1082BM-HS

Oldalcsípőfogó, krómozott,
gumibetétes műanyag nyéllel

UNI/ISO 5749

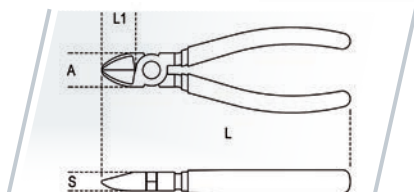

	L mm	L1 mm		A mm	S mm	g
010824036	160	22	1,6	28	12	215

1088BM-HS

Erősített homlokcsípőfogó,
krómozott, gumibetétes
műanyag nyéllel

UNI/ISO 5748

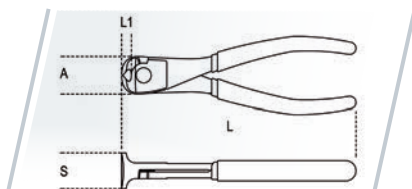

Ábr.	L mm	L1 mm	mm	A mm	S mm	g
010884036	160	9	1,6	28	11	230
010884040	200	11	2,0	36	13	370

1128BAX-HS

Kettős hatású villanszerelő olló,
lépcsős profil, rozsdamentes acél,
DLC bevonat

- Kettős hatású vágás
- DLC bevonat: Nagy felületi keménység a pengénél (nagy kopásállóság és időtálló pengeélesség)
- Lépcsős profil: 13 és 24 mm közötti furatok tágítására létrehozva műanyagokon



Ábr.	L mm	L1 mm	mm ²	g
011284088	150	50	50	200

1132BM-HS

Kábelvágó, krómozott,
gumibetétes műanyag nyéllel

UNI 8791

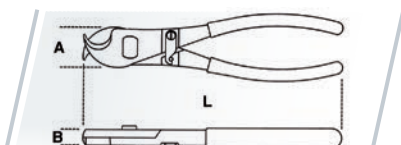





Ábr.	L mm	mm	mm ²	A mm	B mm	g
011324143	230	18	95	37	12,5	394

1150BM-HS

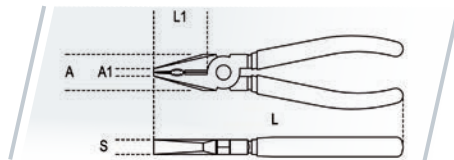
Kombinált fogó, krómozott, polírozott, gumibetétes műanyag nyéllel

ISO 5746







	L mm	L1 mm		A mm	A1 mm	S mm	
011504036	160	37	1,6	24	6,3	11	200
011504038	180	41	1,8	28	7,1	11	275
011504040	200	45	2,0	32	8,0	14	310

1166BM-HS

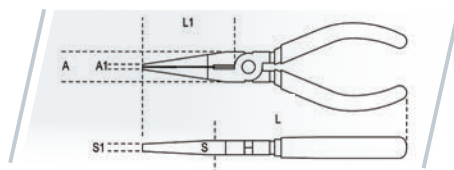
Egyenes extra hosszú félkerekcsőrű fogó, krómozott, gumibetétes műanyag szárral

ISO 5745







	L mm	L1 mm		A mm	A1 mm	S mm	S1 mm	
011664040	200	76	1,6	22,0	5,0	11,0	4,0	200

1168BM-HS

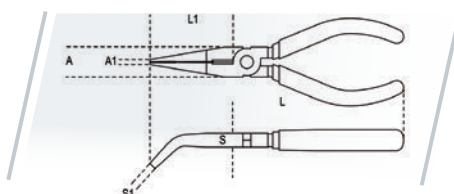
Hajlított extra hosszú félkerekcsőrű fogó, krómozott, gumibetétes műanyag szárral

ISO 5745



	L mm	L1 mm		A mm	A1 mm	S mm	S1 mm	
011684040	200	70	1,6	22,0	5,0	11,0	4,0	210

35HS

Erősített laposvágó,
krómozott

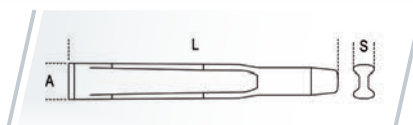

	L mm	A mm	S mm	g
000354004	200	23,0	14	296
000354005	250	28,5	15,5	490

1370FT-HS

Lakatos kalapács, francia
modell, műanyag nyéllel

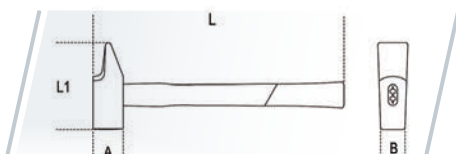

	A mm	L mm	L1 mm	B mm	g
013704528	28	280	86	22	530
013704530	32	280	92	24	625
013704536	36	300	104	29	930

1370T-HS

Lakatos kalapács német
modell műanyag nyéllel

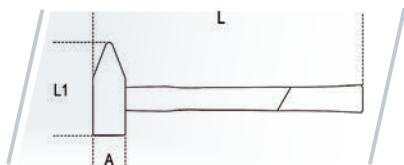

	g	A mm	L mm	L1 mm	g
013704630	300	23	300	105	452
013704650	500	27	320	118	663
013704700	1000	36	360	135	1279

1390HS

Műanyag kalapács,
cserélhető végekkel,
fanyéllel

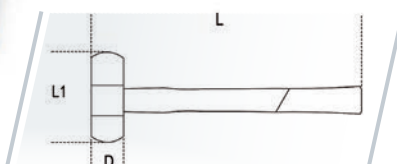

	D mm	L mm	L1 mm	g
013904035	35	310	95	365
013904045	45	320	107	698

1392HS

Ütéselnyelő műanyag kalapács, cserélhető végekkel, acélnyéllel

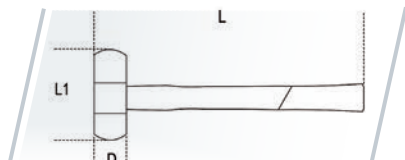

Modell	D mm	L mm	L1 mm	g	Modell	D mm	L mm	L1 mm	g
013924035	35	305	115	670	013924050	50	325	135	1206
013924040	40	310	125	796	013924060	60	385	155	1505

1602AHS

Saruzófogó szigetelt kábelsarukhoz, standard modell, krómozott, műanyag szárral

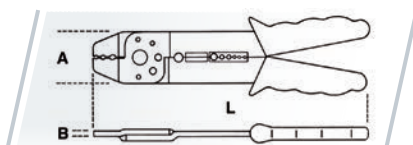

Modell	mm ²	L mm	A mm	B mm	g
016024005	0÷6	220	42	4	263

1760BHS

Univerzális digitális multiméter

VÉGREHAJTHATÓ MÉRÉSEK
 Feszültség DC: 200 mV-2/20/200/1000V
 Feszültség AC: 2-20/200/700V
 Áram DC: 2/20/200 mA-20 A
 Áram AC: 2/200 mA- 20 A
 Ellenállás: 200Ω - 2/20/200 kΩ - 2/20 MΩ
 Kapacitás: 2/20/200 nF - 2/200 μF
 Hőmérséklet: -20° + 1000°C/ -4 °F ~ +2000°F
 Frekvencia: 20kHz
 Tápegység: 1 9V-elem (együtt szállítva)



Modell	g
017604012	670

1682HS

Rugalmas skálás vonalzó,
rozsdamentes acélból



	L mm	H mm	$\pm S$ mm	 g
016824020	200	13	0,5	11
016824030	300	13	0,5	16

1692HS

Mérőszalag, ütészálló
bimateriál ABS-ház,
acélszalag,
pontossági osztály: II



	L mm	S mm	 g
016924053	3	16	110
016924055	5	19	200

1708HS

Metrikus hézagmérő

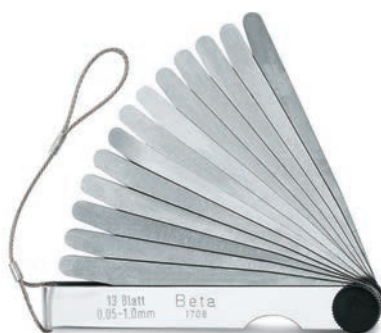

	$\pm S$ mm	$\pm S$ μ	L mm	 g
017084020	0,05÷1	0,002÷0,040	105	100



1727HS

Erősített fűrész,
fűrészkeret lakkozott
acélból, fanyéllal,
bimetal fűrészlappal

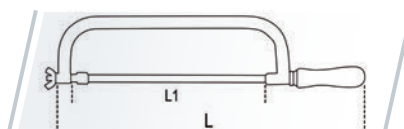
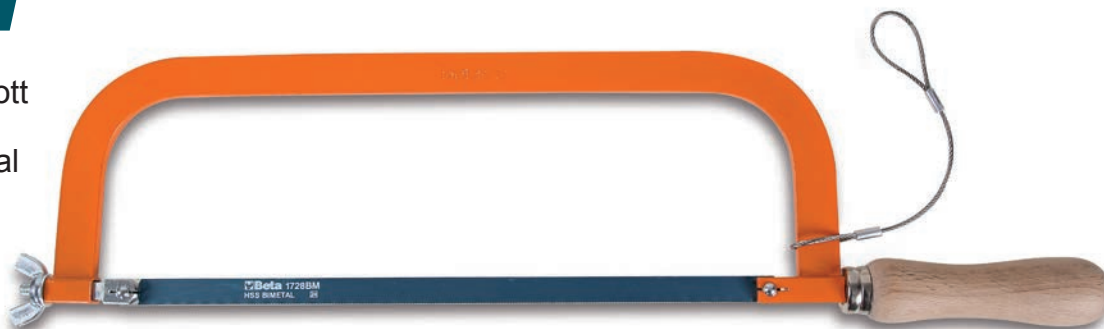

	L mm	L1 mm	 g
017274001	515	300	681

1772H-HS

Kés behúzható pengével,
1 tartalék pengével



	L mm	A mm	 g
017724029	170	18	681

a kiegészítők (tájolók, kulcsok és lemezek) cseréje csak a földön végezhető el

1778SOS-HS

Autós elsősegély kés
ablaktörő kalapács
és biztonsági öv vágó
funkcióval tokban

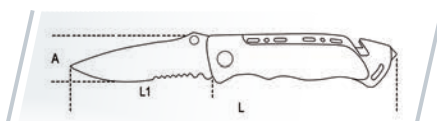

	L mm	A mm	L1 mm	 g
017784080	205	25	85	180

1743HS

Kábelkötegelő fogó

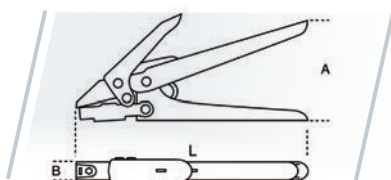

	L mm	A mm	B mm	 g
017434001	195	85	17	282

1750HS

Karoszsírzó



	cc	L mm	 kg
017504500	500	380	1,3

8871

Biztonsági öv, fémcattal és dupla zárral



	L cm min+max	g
088710070	70-100	390
088710100	100-135	400

8877

Amortizált csatoló heveder

• MAX 2.7 kg



	L cm min+max	DxL mm	g
088770080	70-110	40x80	150

8877M

Amortizált csatoló heveder

• Tekeredés megelőző csatlakozóval
• MAX 2.7 kg



	L cm min+max	DxL mm	g
088770510	20-140	30x60	120

TARTOZÉKOK







8872A

Merev szíj

• 8871 övhöz



	D mm	 g
088720050	50	42

8872AS

A zár húzással nyílik

• 8871 övhöz



	D mm	 g
088720525	25	36

8873

Munkaeszköz
hordozó zsák önzáró
és zipzáras zárral

• 8871 övhöz



	LxH mm	 g
088730230	230x230	250



8883

Munkaeszköz hordozó zsák

- 840-es, dörzsölés megelőző nylon
- MAX 20 kg





- A zipzárt a zárvégen blokkoló karabéllyal



- 6 munkaeszköz rögzítő hevederrel
- Belső zsebbel





	DxH cm	 kg
088830030	30x40	1,1

8879

Csuklóvédő húzással nyílik

- MAX 2.7 kg





	D mm	 g
088790025	30	46

8880

Merev csatoló heveder

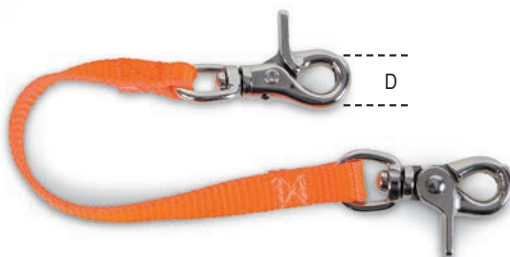
- Tekeredés megelőző csatlakozóval



	L cm	D mm	 g
088800030	30	10	60





Beta
Height-Safe

Delta Manlift®

PORTATA MAX
265Kg

998011032



Beta
H-SAFE

The logo features a stylized orange icon of a wrench and a screwdriver crossed, followed by the word 'Beta' in a bold, orange, sans-serif font, and 'H-SAFE' in a bold, white, sans-serif font below it.

Beta Utensili S.p.A.
Via Volta 18
20845 Sovico (MB) - Italy
Tel. +39 039.2077.1
Fax +39 039.2010742
www.beta-tools.com